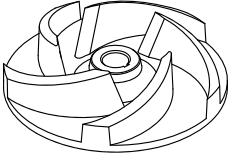

HYDROPOMPE	OPEN IMPELLER 	60 Hz
HYDRO SERIES		2 POLE
11K2 - 15K2		

USE

Submersible electric pumps suitable for the lifting of clear and dirty water. They are especially used in building yards and for pumping abrasive liquids.

MATERIALS

Pump housing

Cast iron EN GJL 200 (UNI EN 1561) with rubber coating

Wear plate

Cast iron EN GJL 200 (UNI EN 1561) with rubber coating

Motor housing

Cast iron EN GJL 250 (UNI EN 1561)

Cover

Cast iron EN GJL 250 (UNI EN 1561)

Impeller

High chrome cast iron

Mechanical seal motor side

Ceramics/Graphite

Mechanical seal impeller side

Silicon Carbide/Silicon Carbide (SiC/SiC)

Motor shaft

Stainless steel AISI 431

Strainer

Stainless steel AISI 304

Cooling jacket

Stainless steel AISI 304

Bolts and nuts

Stainless steel Grade A2

Cable

20 meters 7G4mm²+2x1,5mm² type 07RN8-F

LIMITS TO USE

Max temperature of the liquid pumped

+40°C

pH of the liquid pumped

6÷10

Max immersion depth

20 m

Liquid density

1,1 kg/dm³

Min immersion depth

200 mm

Free passage

6 mm

Max number starts/hour

10

Acoustic pressure level issued

<70dB(A)

MOTOR

The electric motor is asynchronous with squirrel cage rotor in dry chamber

Class of insulation F

Protection degree IP68

2pole; 60Hz

Main voltage values and relative tolerance in relation to the rated voltage value:

THREE-PHASE

400V ±10%

Other voltages on request.

OTHER FEATURES ON REQUEST

Frequency 50 Hz (*see specific catalogue*)

Other voltages

Inner control of the thermal probes in the winding, control sequence and lack of phase

TECHNICAL DATA

MODEL	P1 kW	P2		VOLTAGE V	CURRENT A	CABLE m	WEIGHT kg
		kW	CV				
11K2 BP	13	11	14,9	400/690 (3~)	22	20	192
15K2 BP	17	15	20,4	400/690 (3~)	28	20	204
11K2 AP	13	11	14,9	400/690 (3~)	22	20	192
15K2 AP	17	15	20,4	400/690 (3~)	28	20	204

HYDRO SERIES	11K2 - 15K2		OPEN IMPELLER	60 Hz
				2 POLE

PERFORMANCE RANGE

CAPACITY															
<i>l/s</i>	0	5	10	15	20	25	30	35	40	45	50	55	60	65	70
<i>m³/h</i>	0	18	36	54	72	90	108	126	144	162	180	198	216	234	252
<i>l/min</i>	0	300	600	900	1200	1500	1800	2100	2400	2700	3000	3300	3600	3900	4200

MODEL	CURVE N°	HEAD <i>m</i>														
		32,0	29,6	26,9	24,2	21,6	18,6	15,5	13,2	10,9	9,0	7,1	5,1	-	-	-
11K2 BP	1	32,0	29,6	26,9	24,2	21,6	18,6	15,5	13,2	10,9	9,0	7,1	5,1	-	-	-
15K2 BP	2	34,0	32,5	30,4	28,1	26,1	23,6	20,9	18,9	16,2	14,0	11,3	9,4	7,1	4,4	-
11K2 AP	3	60,0	51,1	42,1	32,2	20,8	8,9	-	-	-	-	-	-	-	-	-
15K2 AP	4	62,0	56,8	51,4	43,5	34,0	25,2	14,4	2,0	-	-	-	-	-	-	-

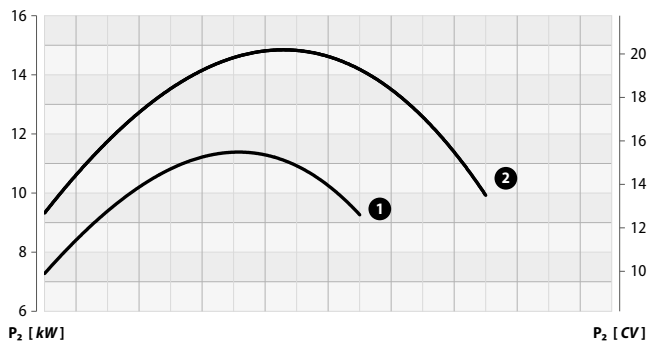
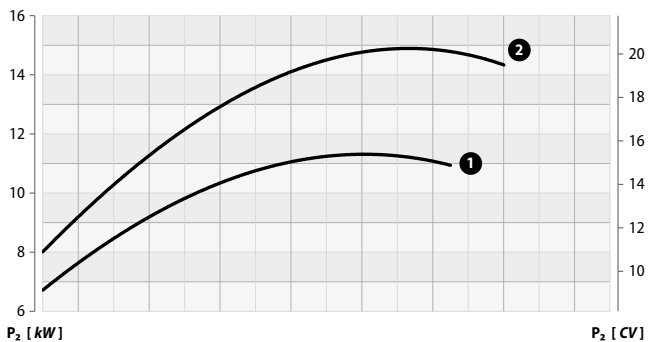
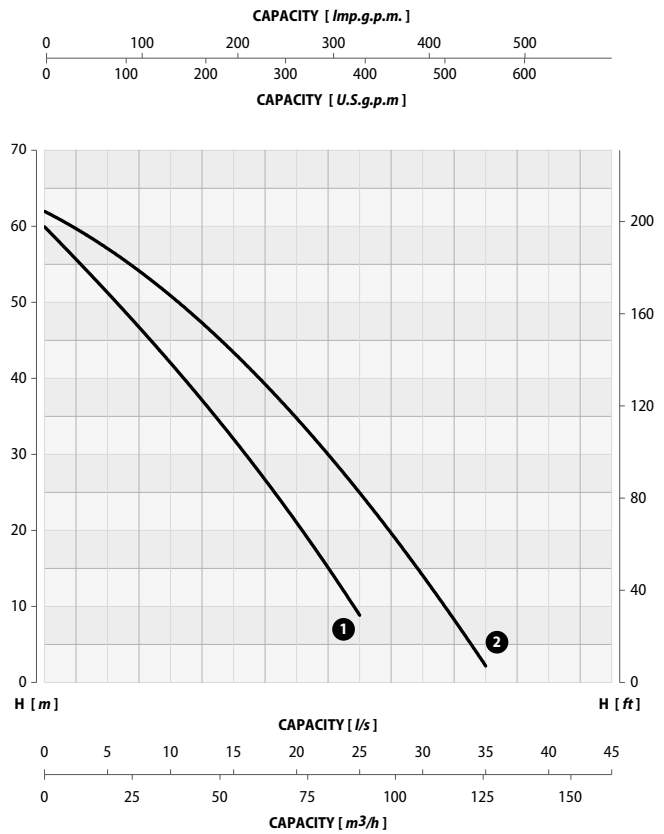
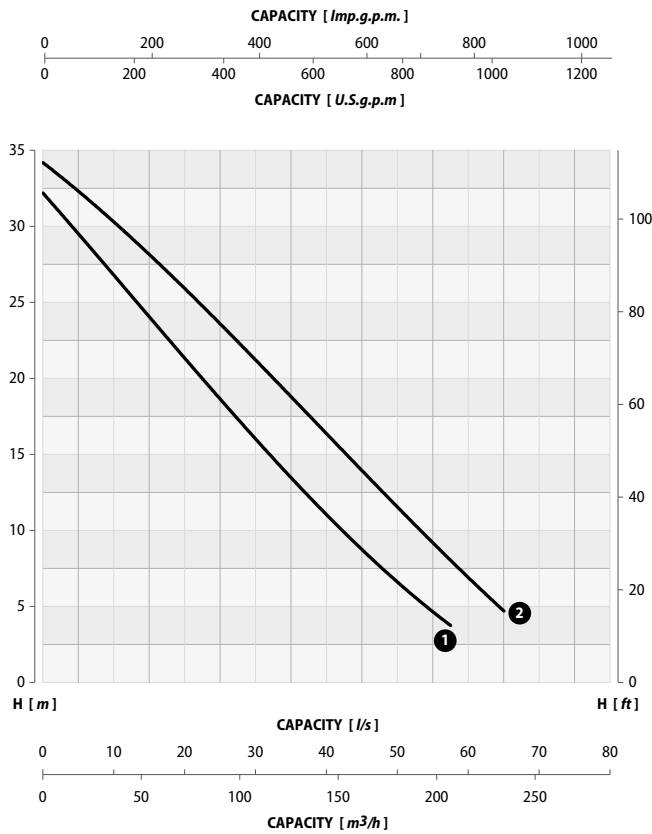

Performance tolerance in according to UNI/ISO 9906 Grade 3B

HYDRO SERIES	11K2 - 15K2		OPEN IMPELLER	60 Hz
				2 POLE

INSTALLATION DIMENSIONS

